

Package Dimensions:

**Package Dimensions
QFN 48**

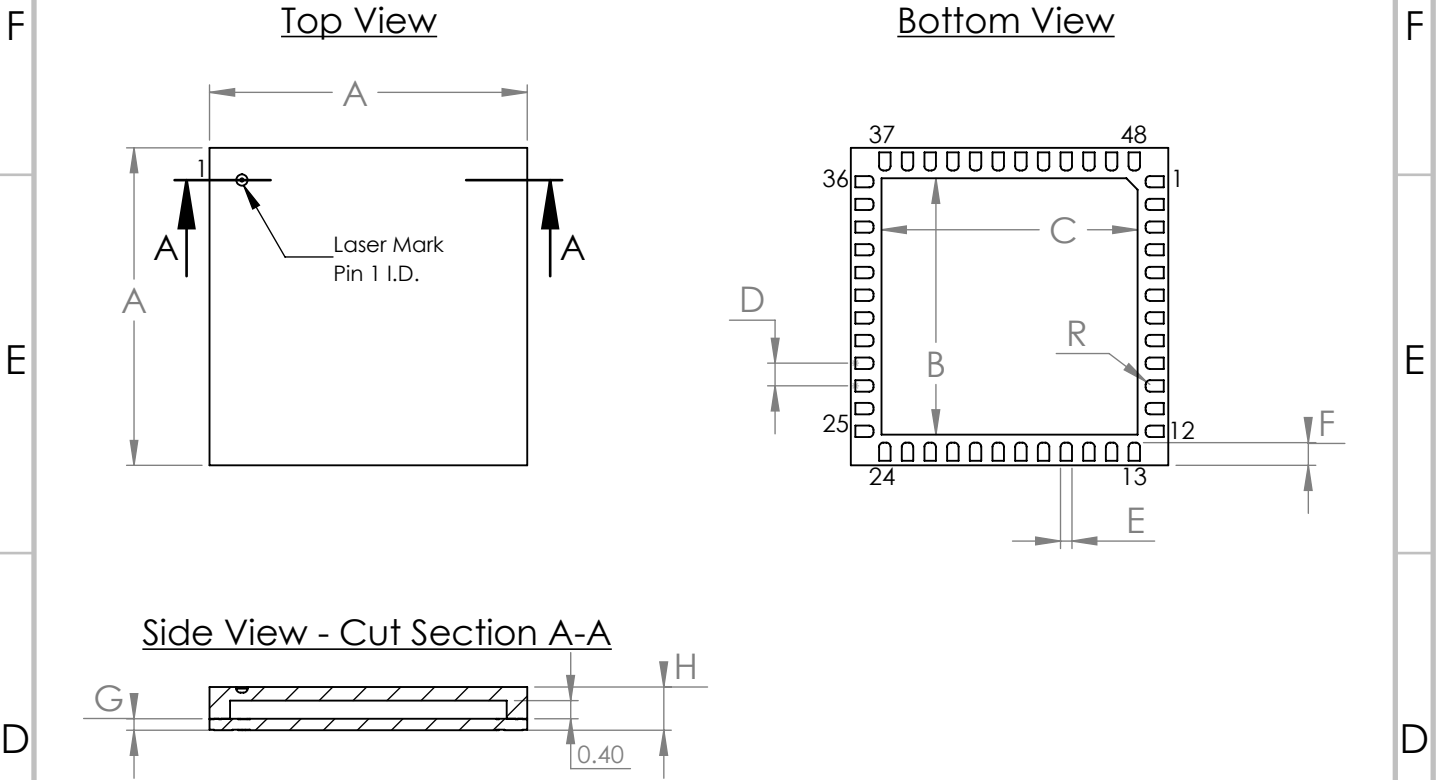

Table of Dimensions

48 Pin QFN Package (7mmx7mm)

No. of Leads	SYMBOL								
	A	B	C	D	E	F	G	H	R
48 (7x7 mm)									
MIN (mm)	7	5.5	5.5	0.5	0.15	0.45	0.254	0.85	0.09
NOM (mm)		5.65	5.65		0.25	0.5		0.95	
MAX (mm)					0.30	0.55		1.05	

Notes:

1. Conforms to JEDEC standard JESD-30 MO-220
2. All dimensions are in millimeters



Substrate 7x7 48 :

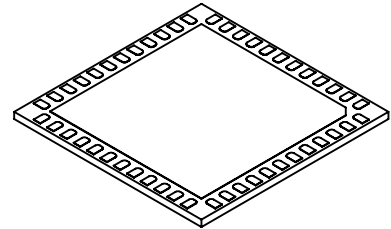
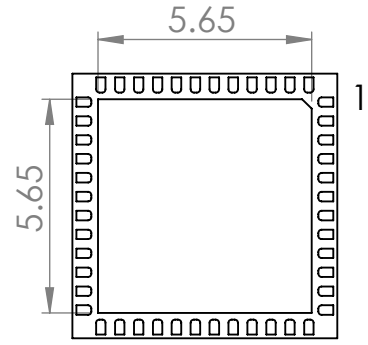
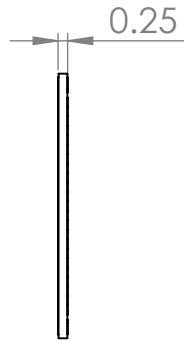
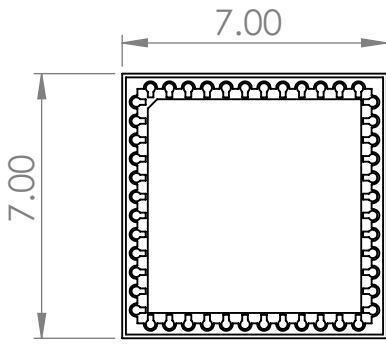

Lid 7x7 :

